

Fő méretek

Teljes hossz 2,20 m
 Vízvonalhossz 2,20 m
 Szélesség 0,90 m
 Oldalmagasság 0,4 m
 Merülés 0,25 m
 Szabadoldal 0,15 m
 Vízkiszorítás m³

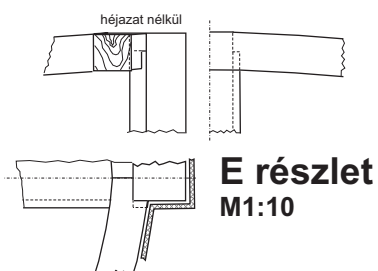
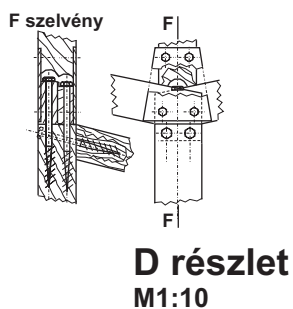
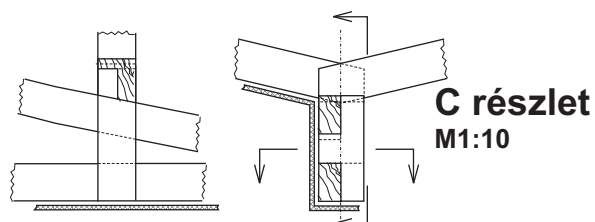
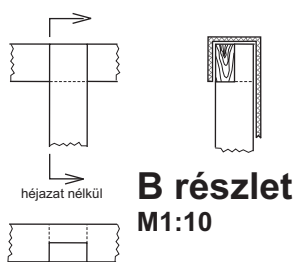
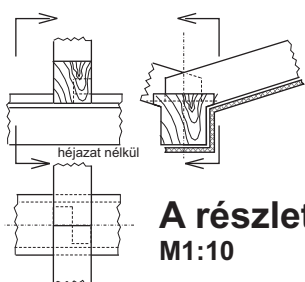
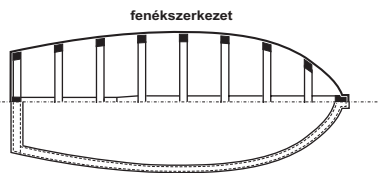
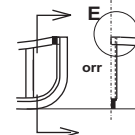
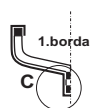
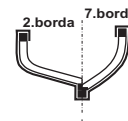
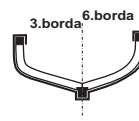
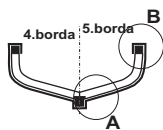
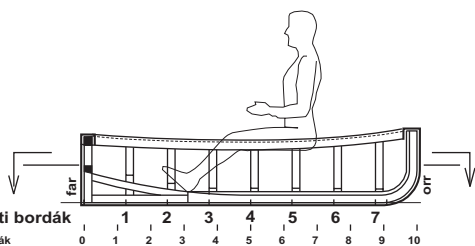

BBBZ2.2 evezős csónak M1:50

1. lap: Általános elrendezés és
merevítő-szerkezet

Evezők és villák

Padok

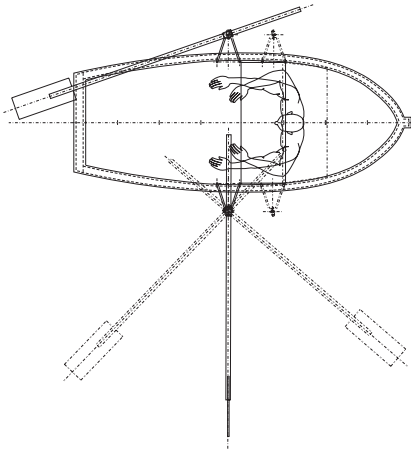
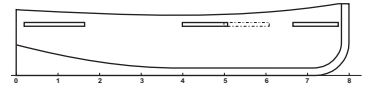
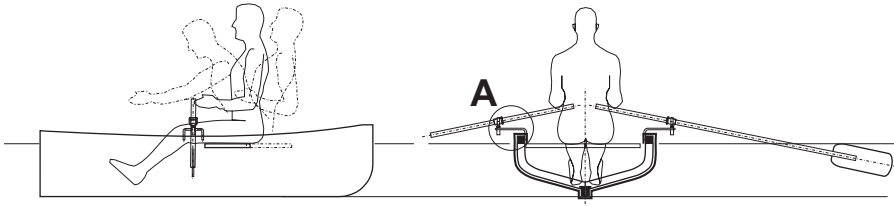

A részlet
M1:10

