

Fő méretek

Teljes hossz 4,25 m

Vízvonalhossz 4,00 m

Szélesség 1,60 m

Oldalmagasság 0,75 m

Merülés 0,44 m

Szabadoldal 0,31 m

Vízkiszorítás m³

Kormánylapát felülete 0,071 m²

Teljes vitorlafelület 6,61 + 1,78 m²

BBBZ4 vitorlás csónak M1:50

1. lap: Általános elrendezés

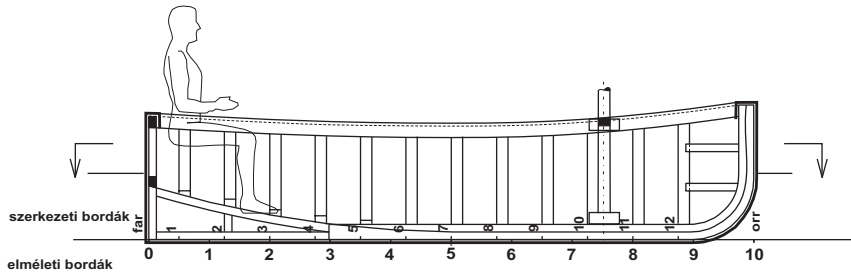

fenékszerkezet

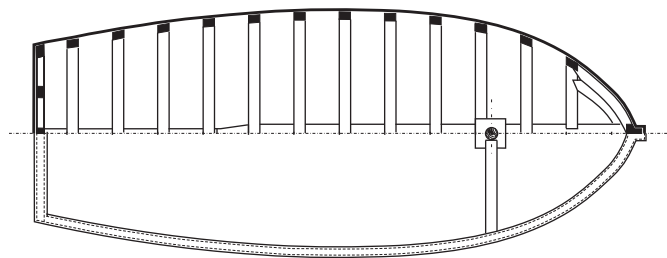

fedélzeti szerkezet

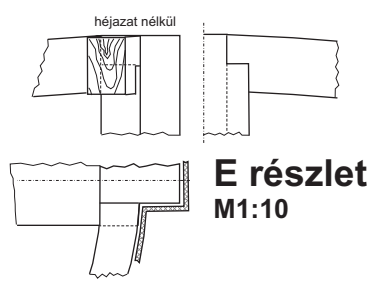
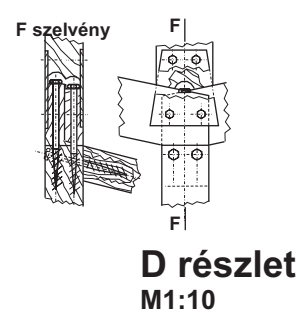
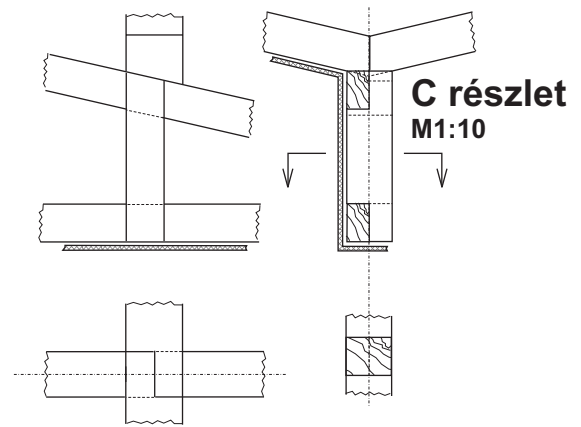
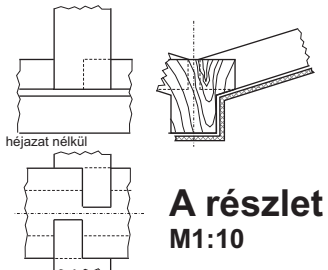
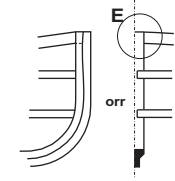
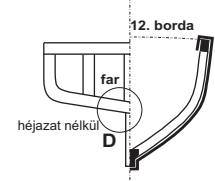
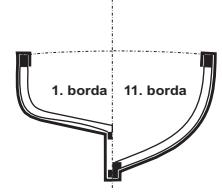
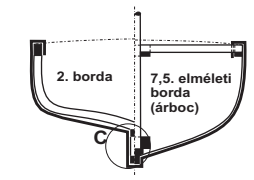
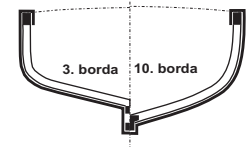
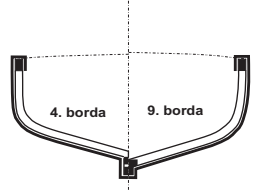
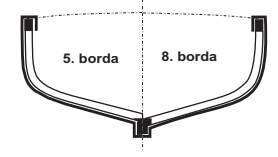
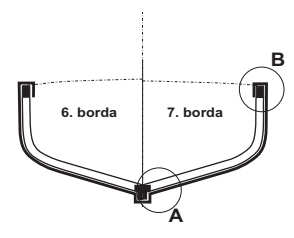

BBZ4 vitorlás csónak
M1:50
 2. lap: Merevítő-szerkezet

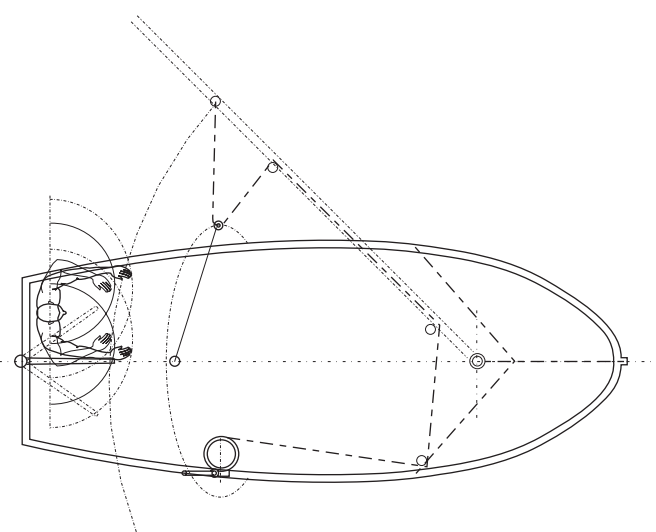
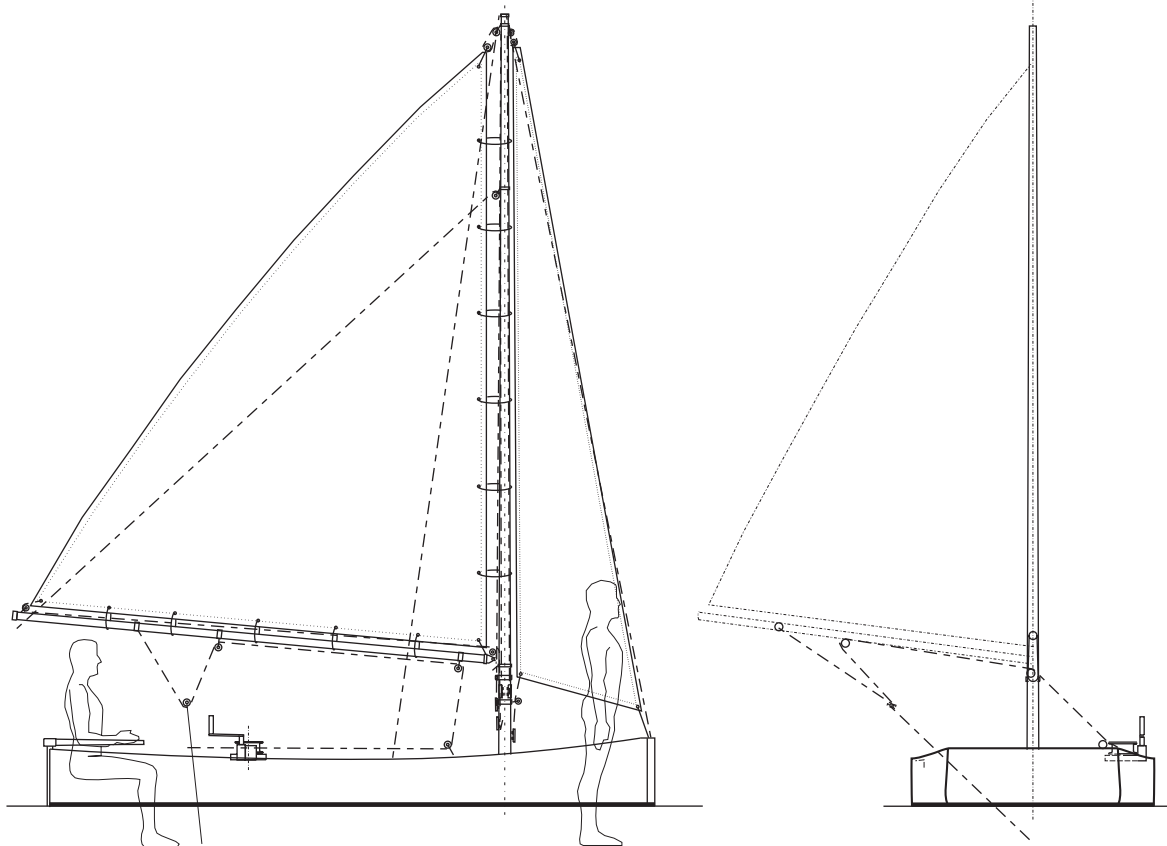

BBZ4 vitorlás csónak
M1:50
3. lap: Vitorlák és kötelek

Kötélcsörlő

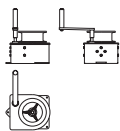

Kormány

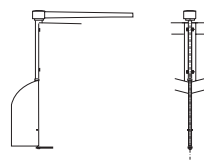

Bikák

Árbocbika



Kikötőbika



Horgony

nyitva zárva



Szemescsavarok



Kikötőkötelek



Padló

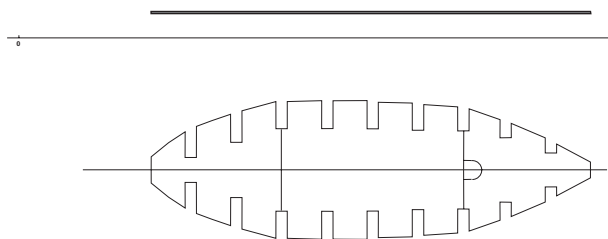

Padok

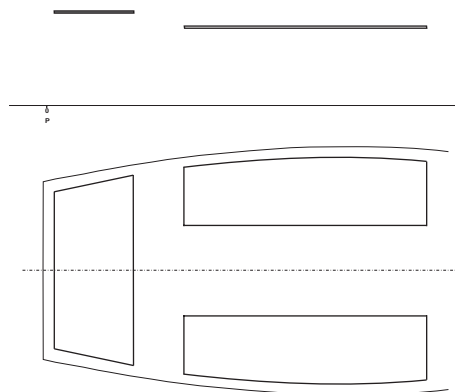

BBBZ4 vitorlás csónak

M1:50

4. lap: Felszerelések és berendezések

